

J johansson
the original

Optical Receiver
5 wavelengths

REF. 4015

V 1310 H 1330 V 1350

OPTICAL INPUT

Optical input
Optical input level
Frequency range RF output
Output Level CATV (AGC)
Output Level SAT (AGC)
DC Input / Power Consum

Power



V H
DC

Fiber Optical Distribution



johansson
since 1962

ENGLISH VERSION
2023

Fiber Optical Distribution

New fiber distribution range

We proudly present our new **fiber distribution range**: an easy-to-install solution to equip buildings with a fiber system or to replace traditional coaxial systems by a compact fiber system. This results in longer distance reach, lower signal degradation and lower equipment costs. These budget friendly products solve cable losses in large MDU's, ideal for high buildings, tourist areas, compounds, etc.

We offer an end-to-end solution starting from the LNB/antenna over fiber to the STB. RF, SAT & CATV signals can be distributed over 5 optical wavelengths (1310, 1330, 1350, 1370, 1550 nm)

Our range includes:

- Fiber Headends with satellite wideband (or RF fullband) and CATV inputs
- Fiber Receivers with satellite wideband and CATV outputs
- Fiber Termination Units with integrated SCR technology

The system is compatible with our new range of wideband dSCR multiswitches. All our products are compatible with single mode SC/APC cables.

Compared to other solutions in the market, we offer higher signal quality over more splits. Without a doubt, our satellite fiber distribution range will improve your installations.

Fiber Optical Distribution: How it works

1 The Wideband LNB receives satellite signals and the antenna receives terrestrial signals which then are converted to Wideband V/H and CATV on coaxial network.

2 The optical headend converts 2x Wideband V/H & CATV to optical wavelengths (1310, 1330, 1350, 1370 and 1550 nm) on 1 optical fiber cable.

3 The optical receiver converts 5 optical wavelengths to Wideband V/H and CATV.

The optical Quattro FTU converts 5 optical wavelengths to SCR and CATV.

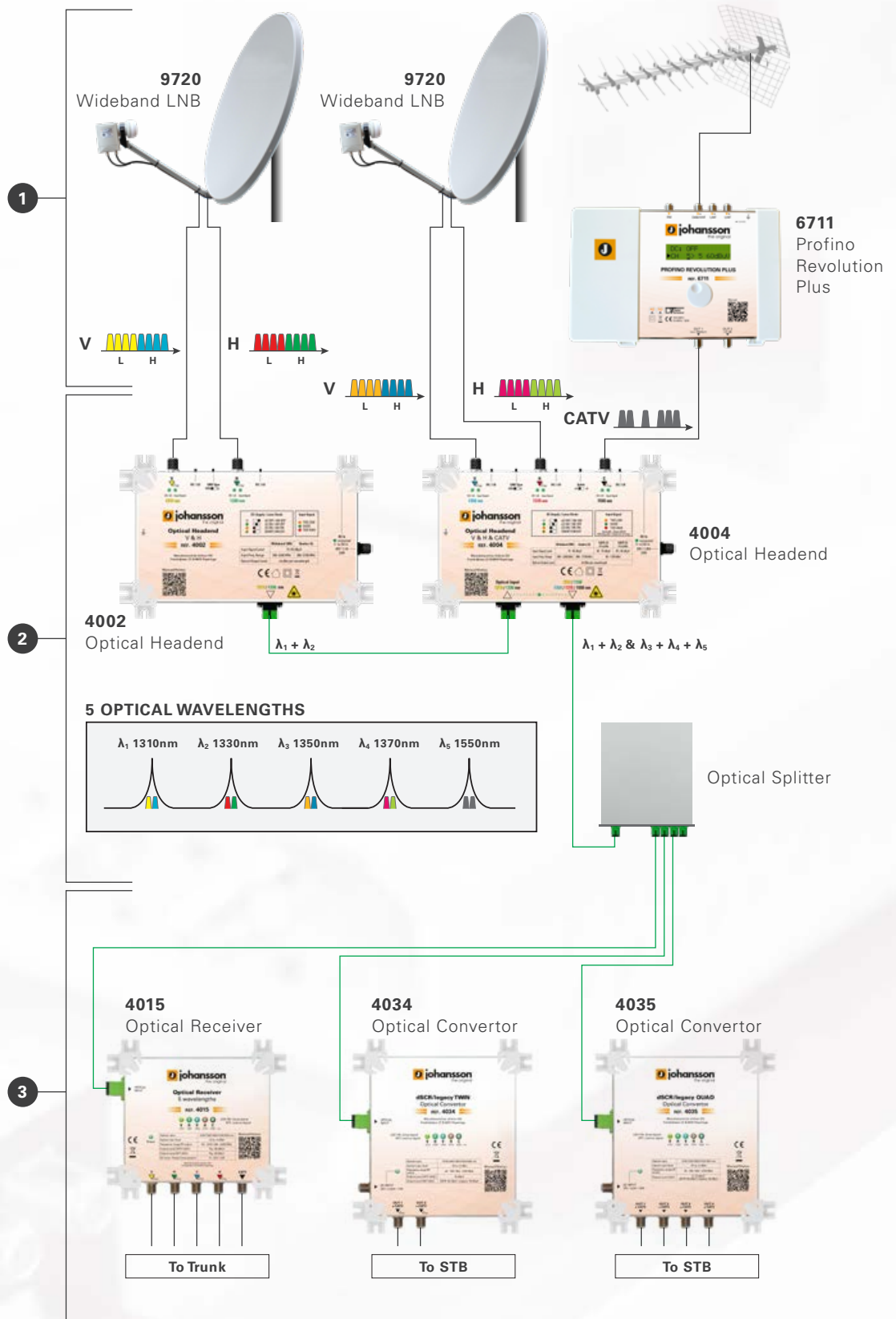

Optical Headend

4002 - 4003

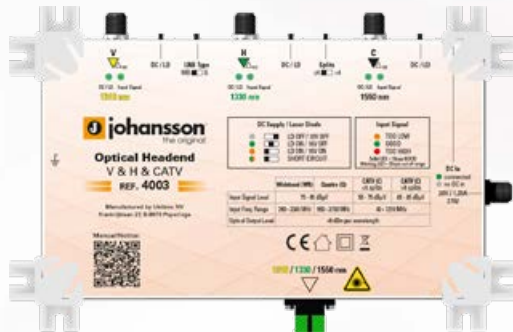

The new **Optical Compact Headend** converts Wideband/ CATV signals to multiple optical wavelengths. Thanks to built-in Automatic Gain Control (AGC) and Automatic Slope Control (ASC), the output signal quality is optimal for your optical distribution system. The Optical Transmitters are suited for many types of optical systems: up to 64 splits, up to 128 splits and even more than 2000 splits!

4002

- 2 Satellite (Wideband / Quattro) inputs
- 1310 - 1330 nm
- AGC & ASC

4003

- 2 Satellite (Wideband / Quattro) and 1 CATV (47 – 1218 MHz) input
- 1310-1330-1550 nm
- AGC & ASC

Specifications 4002 - 4003

		4002	4003
RF Inputs (F-connector)	-	2 x Satellite (Wideband / Quattro)	2 x Satellite (Wideband / Quattro) 1 x CATV
Input frequency SAT	MHz	Wideband: 290 - 2340 Quattro: 950 - 2150	
Input frequency CATV/RF	MHz	-	40 - 1218
Optical output (SC/APC)	-	1	
Optical output wavelengths	nm	1310 - 1330	1310 - 1330 - 1550
Optical output power	dBm	+9 (per wavelength)	
Input level SAT (per Transponder)	dBμV	75 - 95	
Input level CATV/RF (per Transponder)	dBμV	-	55 - 75 (≤ 4 splits) 65 - 85 (> 4 splits)
DC on SAT/RF input	-	18 V / 400 mA	
DC on CATV input	-	-	12 V / 200 mA
Automatic Gain Control	dB	15	
Automatic Slope Control	dB	10	
Max. power consumption (including DC-power at inputs)	W	22	27
DC input (F-type)	-	20 V / 1.1 A	20 V / 1.35 A
Power supply	-	Use a 20 V / 3,25 A Power Supply (Ref. 2460 not included with product)	
Operating temperature range	°C	-10 to +50	
Dimensions	mm	221 x 141 x 50	
Weight	kg	0.8	

Optical Headend 4004

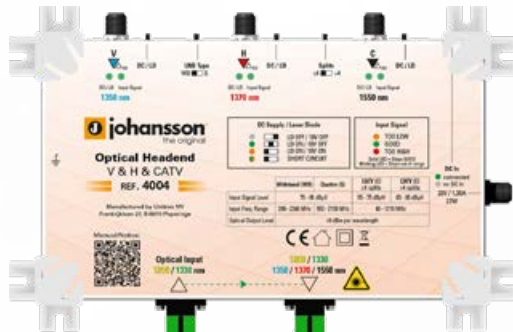

The new **Optical Compact Headend** converts Wideband/ CATV signals to multiple optical wavelengths. Thanks to built-in Automatic Gain Control (AGC) and Automatic Slope Control (ASC), the output signal is of optimal quality for your optical distribution system. The 4004 can be used in combination with the 4002. Combined, they both serve as a headend for the fiber system with 5 wavelengths.

4004

- 2 Satellite (Wideband / Quattro) inputs
- 1350 - 1370 - 1550 nm
- AGC & ASC
- 1 bypass input to combine 1310 and 1330 from ref. 4002

Specifications 4004

		4004
RF Inputs (F-connector)	-	2 x Satellite (Wideband / Quattro) & 1 x CATV
Input frequency SAT	MHz	Wideband: 290 - 2340 Quattro: 950 - 2150
Input frequency CATV/RF	MHz	40 - 1218
Optical output (SC/APC)	-	1
Optical input (SC/APC)	-	1
Optical output wavelengths	nm	1310 - 1330 (Bypass) 1350 - 1370 - 1550
Optical output power	dBm	+9 (per wavelength)
Input level SAT (per Transponder)	dBμV	75 - 95
Input level CATV/RF (per Transponder)	dBμV	55 - 75 (≤ 4 splits) 65 - 85 (> 4 splits)
DC on SAT/RF input	-	18 V / 400 mA
DC on CATV input	-	12 V / 200 mA
Automatic Gain Control	dB	15
Automatic Slope Control	dB	10
Max. power consumption (including DC-power at inputs)	W	27
DC input (F-type)	-	20 V / 1.35 A
Power supply	-	Use a 20 V / 3,25 A Power Supply (Ref. 2460 not included with product)
Operating temperature range	°C	-10 to +50
Dimensions	mm	221 x 141 x 50
Weight	kg	0.8

Optical Headend

4005 - 4006 - 4007

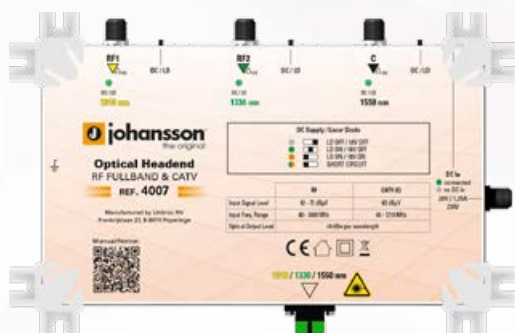

The 4005/4006/4007 are similar to 4002 and 4003 without integrated AGC and ASC.

They also receive RF fullband signals (40-2400 MHz).

The Optical Transmitters are suited for many types of optical systems: up to 64 splits, up to 128 splits!

4005

- 1 Full band (40-2400 MHz) input
- 1550 nm

4007

- 2 Full band (40-2400 MHz) and 1 CATV inputs
- 1310-1330-1550 nm

4006

- 2 Full band (40-2400 MHz) inputs
- 1310-1330 nm

Specifications 4005 - 4006 - 4007

		4005	4006	4007
RF Inputs (F-connector)	-	1 x Full band	2 x Full band	2 x Full band & 1 x CATV
Input frequency RF	MHz	-	40 - 2400	
Input frequency CATV	MHz	40 - 2400	-	40 - 1218
Optical output (SC/APC)	-	1		
Optical output wavelengths	nm	1550	1310 - 1330	1310 - 1330 - 1550
Optical output power	dBm	+9 (per wavelength)		
Input signal level RF	dBμV	62 (64QAM) - 67 (16QAM) - 72 (QPSK)		
Input level CATV	dBμV	62	-	62
DC on RF input	-	18 V / 400 mA		
DC on CATV input	-	-	-	12 V / 200 mA
Max. power consumption (including DC-power at inputs)	W	10	20	25
DC input (F-type)	-	20 V / 0.5 A	20 V / 1 A	20 V / 1.25 A
Power supply	-	Use a 20 V / 3,25 A Power Supply (Ref. 2460 not included with product)		
Operating temperature range	°C	-10 to +50		
Dimensions	mm	221 x 141 x 50		
Weight	kg	0.8		



Optical receiver

The **optical receiver** is developed for the transmission of wideband signals in medium and large Fiber Optic systems. The Optical receiver can convert one, two, three or five wavelengths.

Optical Receiver

4011 - 4012 - 4013 - 4014



Optical receivers developed for the transmission of wideband signals in medium and large Fiber Optic systems. The Optical receiver can convert one, two or three wavelengths. Ref. 4011 (Optical Single Receiver) converts 1550nm to Satellite or CATV signal. Ref. 4012 (Optical Dual Receiver) converts 1310 + 1330 nm to wideband V/H; Ref. 4013 (Optical Triple Receiver) converts 1310 + 1330 + 1550 nm to wideband V/H and CATV signal. Ref. 4014 (Optical Triple Receiver) converts 1350 + 1370 + 1550 nm to wideband V/H and CATV signal.

- Optical input level: -15 to +4 dBm
- Frequency range: 40 - 2400 MHz
- High reception quality even with high split ratios
- Powering via V or H output (12V - 20V)
- AGC to boost signal level
- Compatible with Johansson wideband Multiswitches (e.g. 9775, 9754, 9758, 9734, etc.) with double F male adaptors or jumpercables
- Up to 128 passive splits
- **Power supply:** Ref. 2462 (optional)
- **Power inserter:** Ref. 9669 (optional)

Specifications 4011 - 4012 - 4013 - 4014

		4011	4012	4013	4014
Optical inputs	-			1	
RF outputs	-	1	2	3	
Optical wavelength	nm	1550	1310 1330	1310 1330 1550	1350 1370 1550
CATV output frequency range	MHz	-	-	40 - 1218	
Satellite output frequency range	MHz	40 - 2400			
Optical input level	dBm	-15 to +4			
RF output level per Tr. (AGC)	dBμV	80			
Signal presence indicator	-	Green LED per wavelength			
Return loss	dB	-10			
Optical connector type	-	SC / APC			
RF connector	-	75 Ohm F type (Female)			
Power consumption	W	1	2	3	
Power supply	VDC	12 - 20 (via DC port (F-type))	12 - 20 (via V or H port (F-type))		
Power indicator	-	Green LED			
Operating temperature range	°C	-10 to +55			
Dimensions	mm	36 x 45 x 125		56 x 45 x 125	
Weight	kg	0.110		0.165	

Optical Receiver 4015



The **Optical Quintuple Receiver** is developed for the transmission of broadband signals in medium and large Fiber Optic systems. Ref.4015 converts 1310 + 1330 + 1350 + 1370 + 1550 nm to 2 x V/H and CATV signal.

- Up to 64 passive splits
- Optical Input Level: -12 to +4 dBm
- Frequency Range: 40 – 2400 MHz
- High reception quality even with high split ratios
- Powering via V/H output (12-20V)
- AGC to boost signal level
- Optical wavelengths: 1310-1330-1350-1370-1550nm
- Compatible with Johansson wideband Multiswitches (e.g. 9775, 9754, 9758, 9734, etc.)
- **Power supply:** Ref. 2462 (optional)
- **Power inserter:** Ref. 9669 (optional)

Specifications 4015

		4015
Optical inputs	-	1
RF outputs	-	Dual WideBand +1x CATV
Optical wavelength	nm	1310 - 1330 - 1350 - 1370 - 1550
CATV output frequency range	MHz	40 - 1218
Satellite output frequency range	MHz	290 - 2400
Optical input level	dBm	-12 to +4
Signal presence indicator	-	Green LED per wavelength
dCSS/dSCR UBs	-	-
Output level Wideband AGC	dB μ V	80
Output level CABLE AGC	dB μ V	80
Return loss	dB	-8 (typ -12)
Input connector type	-	SC / APC
Output connector type	-	75 Ohm F type (Female)
Power consumption	W	5
Power supply via DC IN	VDC	-
Power supply via output (STB)	VDC	12 - 20 (via V or H port (F-type))
Power indicator	-	Green LED
Operating temperature range	°C	-10 to +55
Dimensions	mm	166 x 136 x 50
Weight	kg	0.375

Johansson
the original

Optical Receiver

5 wavelengths

REF. 4015

V
1310

H
1330

V
1350

H
1370

C
1550 nm

LED ON:
OFF

OPTICAL
INPUT

Optical input	1310/1330/1350/1370/1550
Optical input level	-12 to +2 dB
Frequency range RF output	40 - 1218 / 290 - 1218
Output Level CATV (AGC)	Typ. 80
Output Level SAT (AGC)	Typ. 8
DC Input / Power Consumption	12 - 15 W

Manufactured by Unicon NV
Frankrijklaan 27, B-8970 Poperinghe

CE

Power

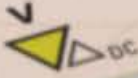

dSCR/legacy

4031 - 4032 - 4033 - 4036



dSCR/legacy Optical Converters with high output power, developed to help installers overcome low signal quality in satellite fiber installations.

- Unique product in the market with high output power
- Optical wavelengths: 1310nm (V), 1330nm (H), 1550nm (C)
- Optical input level: -12 to 0 dBm
- **4031**: 3 outputs: 2 dSCR/legacy/CATV + 1 CATV
- **4032**: 5 outputs:
 - Quad mode: 4 x dSCR/Legacy with CATV
 - Quattro mode: VL, HL, VH, HH, CATV
- **4033**: 5 outputs: Quattro: VL, HL, VH, HH, CATV
- **4036**: 5 outputs: Quattro: VL, HL, VH, HH, CATV
- AGC on all output ports
- Signal quality indicator per wavelength
- Energy efficient
- Power supply: 20V via DC IN (Ref. 4031 and 4032) or from STB (optional ref. 2462)
- Can be used in systems with up to 64 splits
- **Power supply**: Ref. 2462 (optional)

Specifications 4031 - 4032 - 4033 - 4036

		4031	4032 QUAD MODE	4032 QUATTRO MODE	4033	4036
Optical inputs	-	1				
RF outputs	-	3 (2 dSCR/Legacy with CATV + 1 CATV)	4 (dSCR/legacy with CATV)	4x + 1x CATV		
Optical wavelength	nm	1310 1330 1550				1350 1370 1550
CATV output frequency range	MHz	40 - 790				
Satellite output frequency range	MHz	950 - 2150				
Optical input level	dBm	-12 to 0				
Signal presence indicator	-	Green LED per wavelength				
dCSS/dSCR UBS	-	2 x 16	4 x 16	-		
Output level dSCR (AGC)	dBμV	85				78
Output level Legacy (AGC)	dBμV	78				-
Output level CATV (AGC)	dBμV	Out + CATV: 70 CATV: 80	70	80		
Return loss	dB	-10				-8 (typ -12)
Optical connector type	-	SC / APC				
Output connector type	-	75 ohm F type (female)				
Band and polarity selection	-	DiSEqC 1.0 (unidirectional) DiSEqC 2.0 (bidirectional) Standard EN50494/EN50607 SKY UK protocol Universal LNB Voltage & Tone				-
Power consumption	W	8	12			10
Power supply via DC IN	VDC	20				-
Power supply via output (STB)	VDC	12 - 20				
Power indicator	-	Green LED				
Selection Quad or Quattro mode	-	-	Via switch			-
Operating temperature range	°C	-10 to +55				
Dimensions	mm	166 x 136 x 50				
Weight	kg	0.35	0.5			0.5

dSCR/legacy 4034 - 4035



Unique dSCR/legacy TWIN/QUAD Optical Converter with high output power, developed to help installers overcome low signal quality in satellite fiber installations.

- **4034**: 5 optical wavelengths are converted to 2 x dSCR/legacy/CATV
- **4035**: 5 optical wavelengths are converted to 4 x dSCR/legacy/CATV
- Unique product in the market with high output power
- Optical input level: -10 to +2 dBm
- Optical wavelengths: 1310 - 1330 - 1350 - 1370 - 1550nm
- AGC on all output ports
- Signal quality indicator per wavelength
- Sky compatible
- Energy efficient
- Can be used in systems with up to 32 splits
- **Power supply**: Ref. 2462 (optional)

Specifications 4034 - 4035

		4034	4035
Optical inputs	-		1
RF outputs	-	2x dSCR/Legacy/CATV	4x dSCR/Legacy/CATV
Optical wavelength	nm	1310 - 1330 - 1350 - 1370 - 1550	
CATV output frequency range	MHz	40 - 790	
Satellite output frequency range	MHz	950 - 2150	
Optical input level	dBm	-10 to +2	
Signal presence indicator	-	Green LED per wavelength	
dCSS/dSCR UBs	-	2 x 16	4 x 16
Output level dSCR (AGC)	dBμV	85	
Output level Legacy (AGC)	dBμV	78	
Output level CATV (AGC)	dBμV	70	
Return loss	dB	-8 (typ -12)	
Optical connector type	-	SC / APC	
Output connector type	-	75 ohm F type (female)	
Band and polarity selection	-	DiSEqC 1.0 (unidirectional) DiSEqC 2.0 (bidirectional) Standard EN50494/EN50607 SKY UK protocol Universal LNB Voltage & Tone	
Power consumption	W	11	16
Power supply via DC IN	VDC	12 - 20	
Power supply via output (STB)	VDC	12 - 20	
Power indicator	-	Green LED	
Operating temperature range	°C	-10 to +55	
Dimensions	mm	166 x 170 x 50	
Weight	kg	0.43	0.57

Compact Sat IF to IF Headend 9780ETH



The 9780ETH is the **new generation convertor** with cloud access, for satellite signals to be used in MDU's. The compact plug-and-play module has a straightforward and easy configuration. Perfect for equalizing and optimizing satellite transponders as input for your optical headend.

- Multi-functional satellite IF-IF Headend: convertor, stacker, equaliser, optimizer.
- Ethernet port for remote access and web interface
- Up to 32 DVB-S/S2 transponders
- 4 satellite inputs (Quattro/Quad/Wideband LNB)
- Realtime AGC on all individual transponders
- Read-out of input level strength: no need for field strength meter
- 110 dBµV (output level)
- Auto-tuning functionality
- Can be used in Fiber Optic Systems with up to 128 passive splits
- Configure product: www.ucloudserver.com

Fiber Distribution Accessories

Optical PLC Splitters 4040 - 4041 - 4042 - 4043



1 SC/APC to x SC/APC
1260 - 1650 nm

- Ref. 4040: 2-way
- Ref. 4041: 4-way
- Ref. 4042: 8-way
- Ref. 4043: 16-way

Optical Cables 4050 - 4051 - 4052 - 4053



Patch cord in and out SC/APC

- Ref. 4050: 1 m
- Ref. 4051: 10 m
- Ref. 4052: 50 m
- Ref. 4053: 100 m

Optical Attenuators 4060 - 4061 - 4062



In and out SC/APC

- Ref. 4060: 5 dB
- Ref. 4061: 10 dB
- Ref. 4062: 15 dB

Optical link budget

Starting from an optical transmitted power of +9dBm, we can categorize the receivers accordingly:

	4011	4012	4013	4014	4015	4031	4032	4033	4034	4035	4036
Optical range	+4 ↓ -15	+4 ↓ -15	+4 ↓ -15	+4 ↓ -15	+4 ↓ -12	0 ↓ -12	+0 ↓ -12	+0 ↓ -12	+2 ↓ -10	+2 ↓ -10	0 ↓ -12
Min splits	4	4	4	4	4	8	8	8	4	4	8
Max splits	128	128	128	128	64	64	64	64	32	32	64

Table with measured losses

SPLITS	OPTICAL LOSS (dB)	RF LOSS (dB)
1	0	0
2	3,8	7,9
4	6,5	14,9
8	10	20,5
16	13,5	26,4
32	16,5	34,4
64	20	41,8
128	23,5	46,5
256	27	52,3

Conclusion

Wideband receivers with max. 3λ can go up to 128 splits.

Wideband receivers with max. 5λ can go up to 64 splits.

dSCR/quad/quattro receivers with max. 3λ can go up to 64 splits.

dSCR/quad/quattro receivers with max. 5λ can go up to 32 splits.

Note: When using transmitters without AGC, it's important to align the input levels perfectly.

USE CASE 1

GPON RF Overlay: RTV-SAT Distribution over Fiber Optic Network

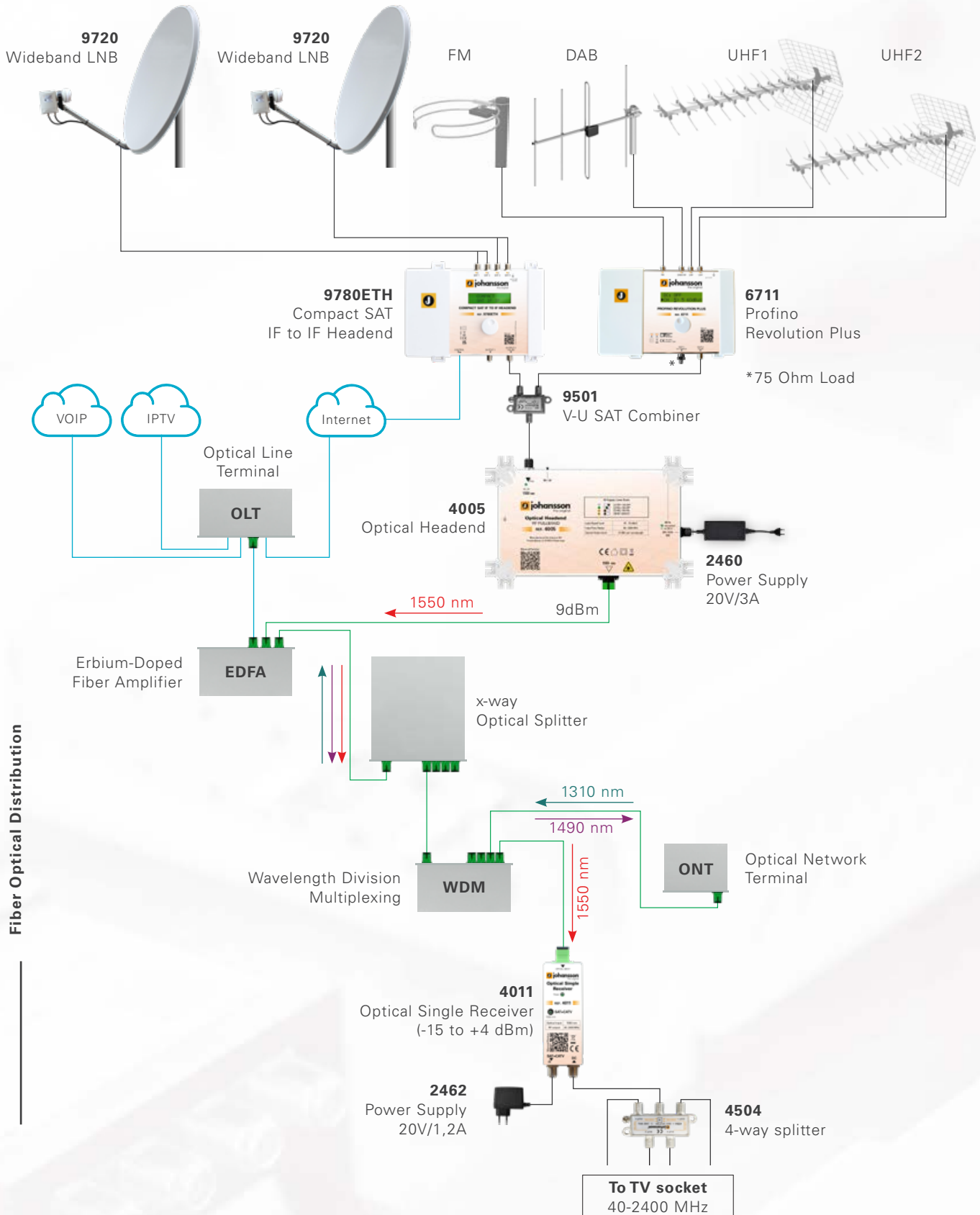

Fiber Optical Distribution

USE CASE 2

RTV-SAT distribution over Fiber Optic Network (up to 64 splits)

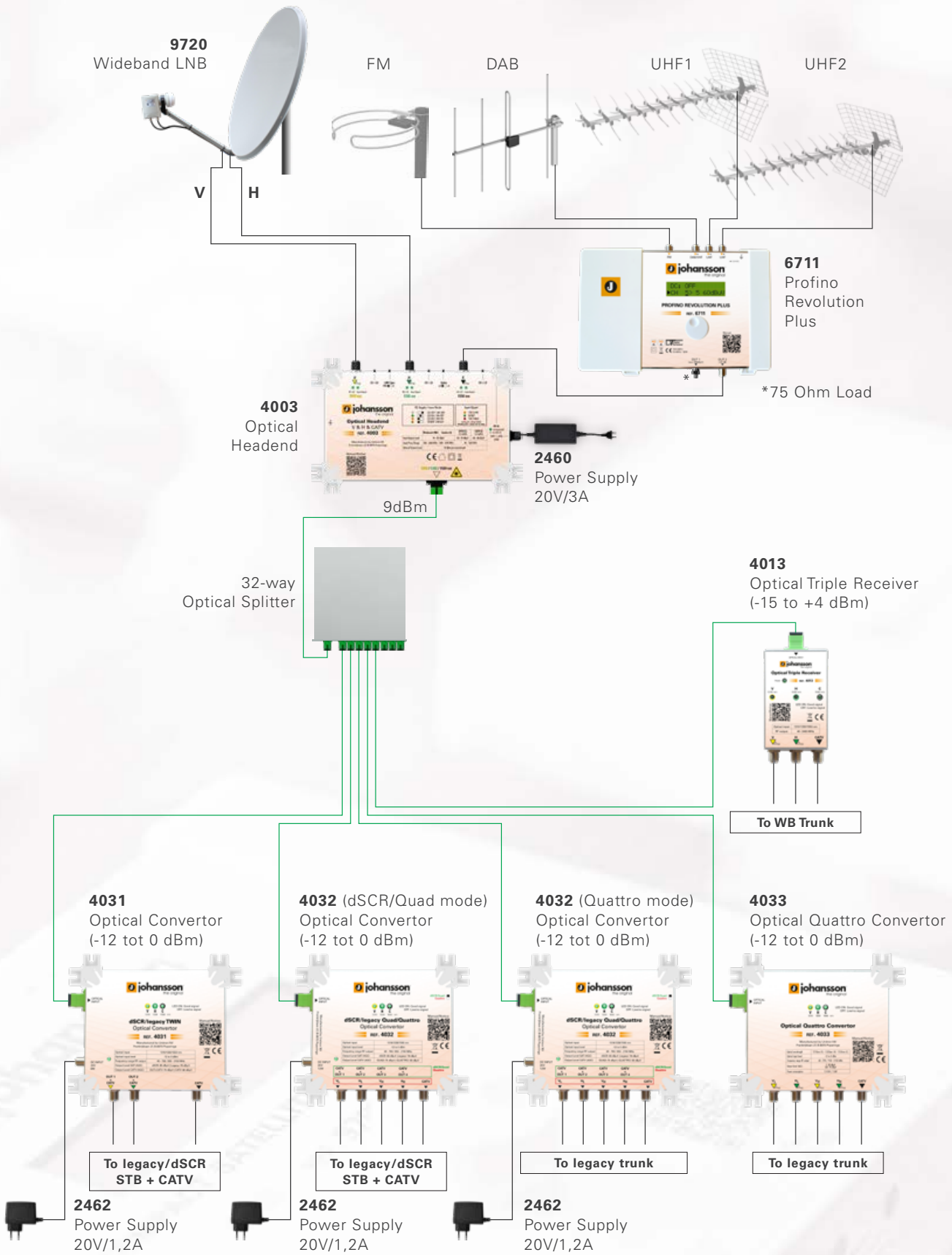

USE CASE 3

RTV-SAT distribution over Fiber Optic Network (up to 64 splits)

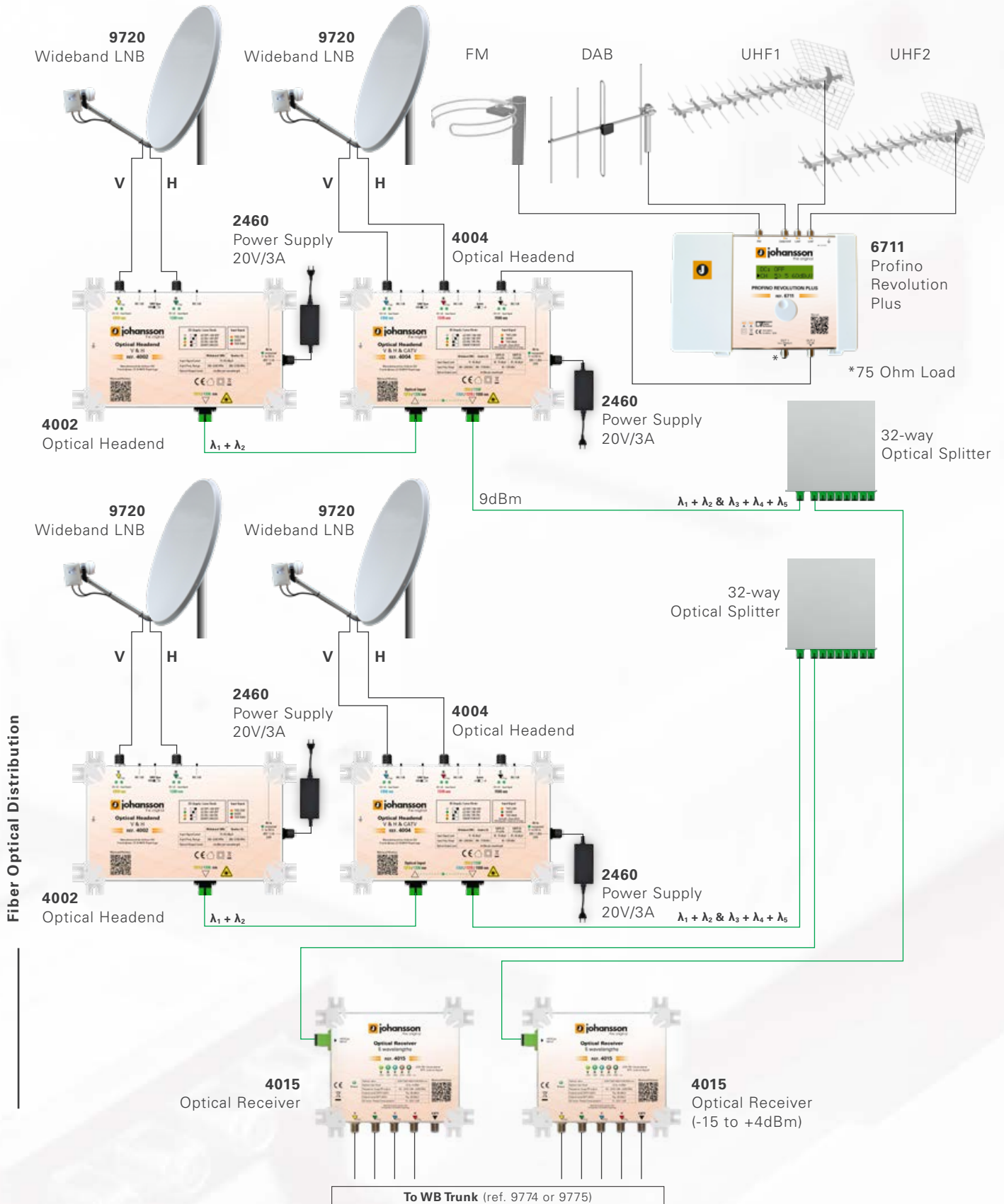

Fiber Optical Distribution

USE CASE 4

RTV-SAT distribution over Fiber Optic Network (up to 32 splits)

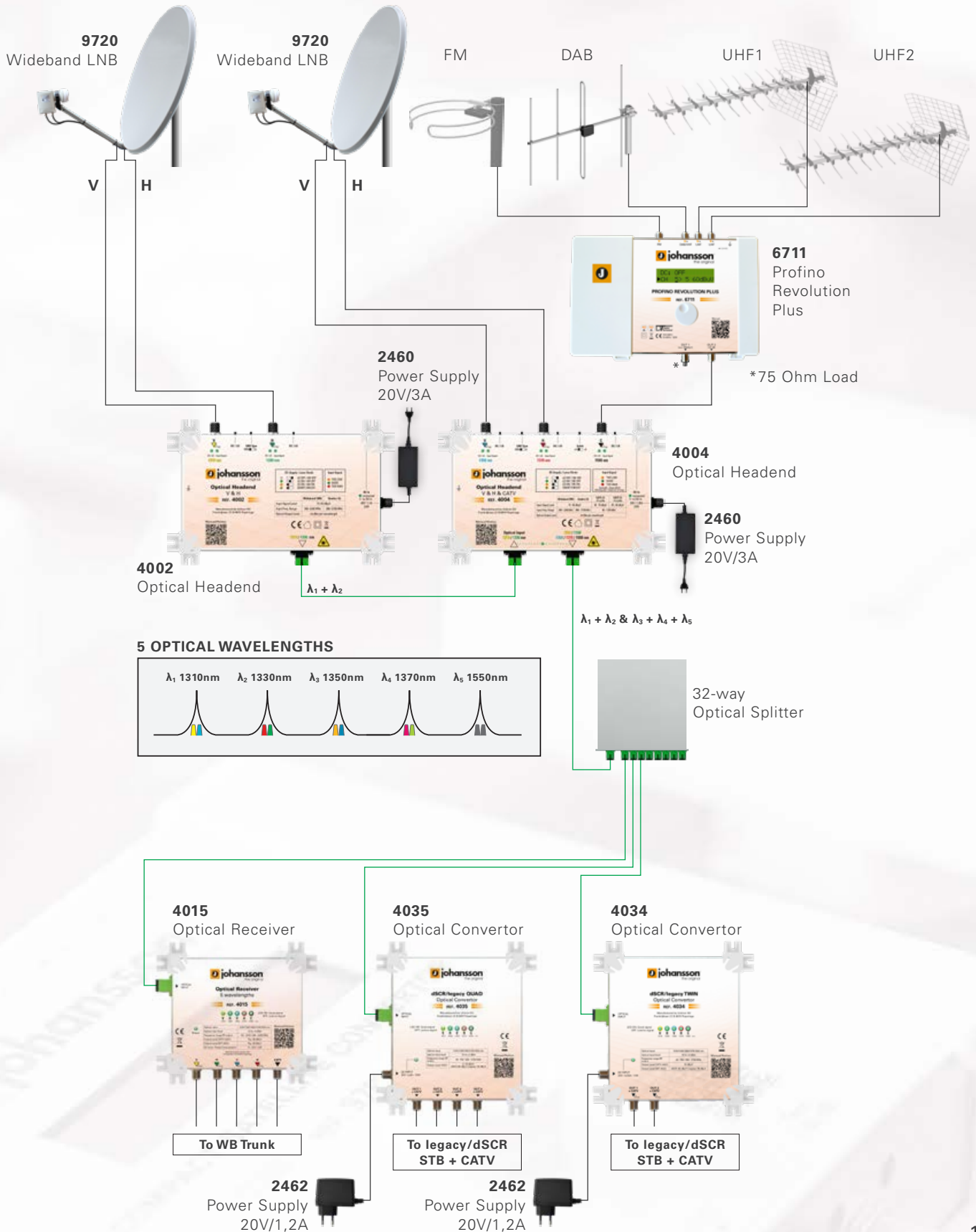

USE CASE 5

RTV-SAT distribution over Fiber Optic Network

ICT-2: according to RD346/2011 (Spanish ICT-law)

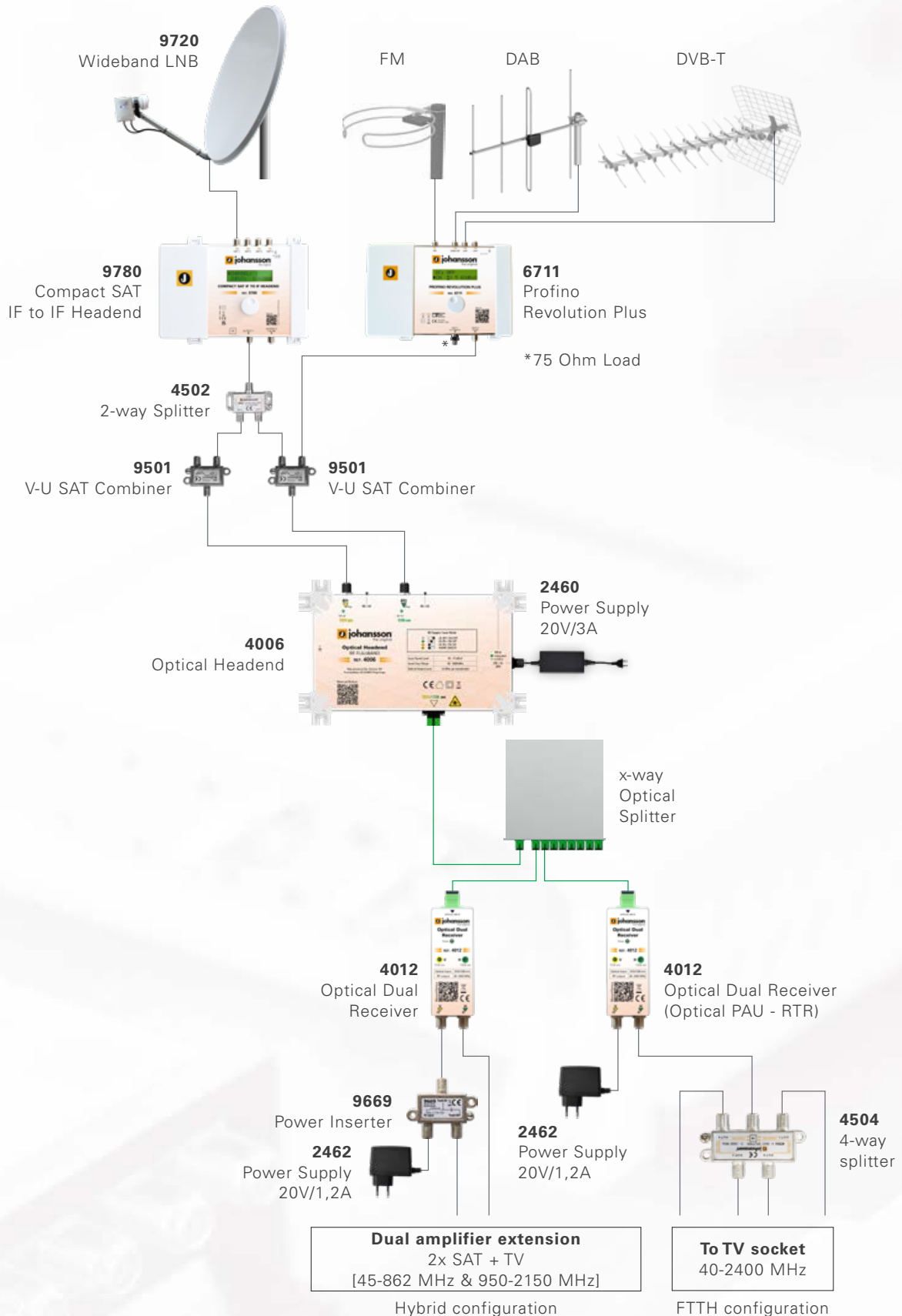

USE CASE 6

Wideband to SCR (up to 64 splits)

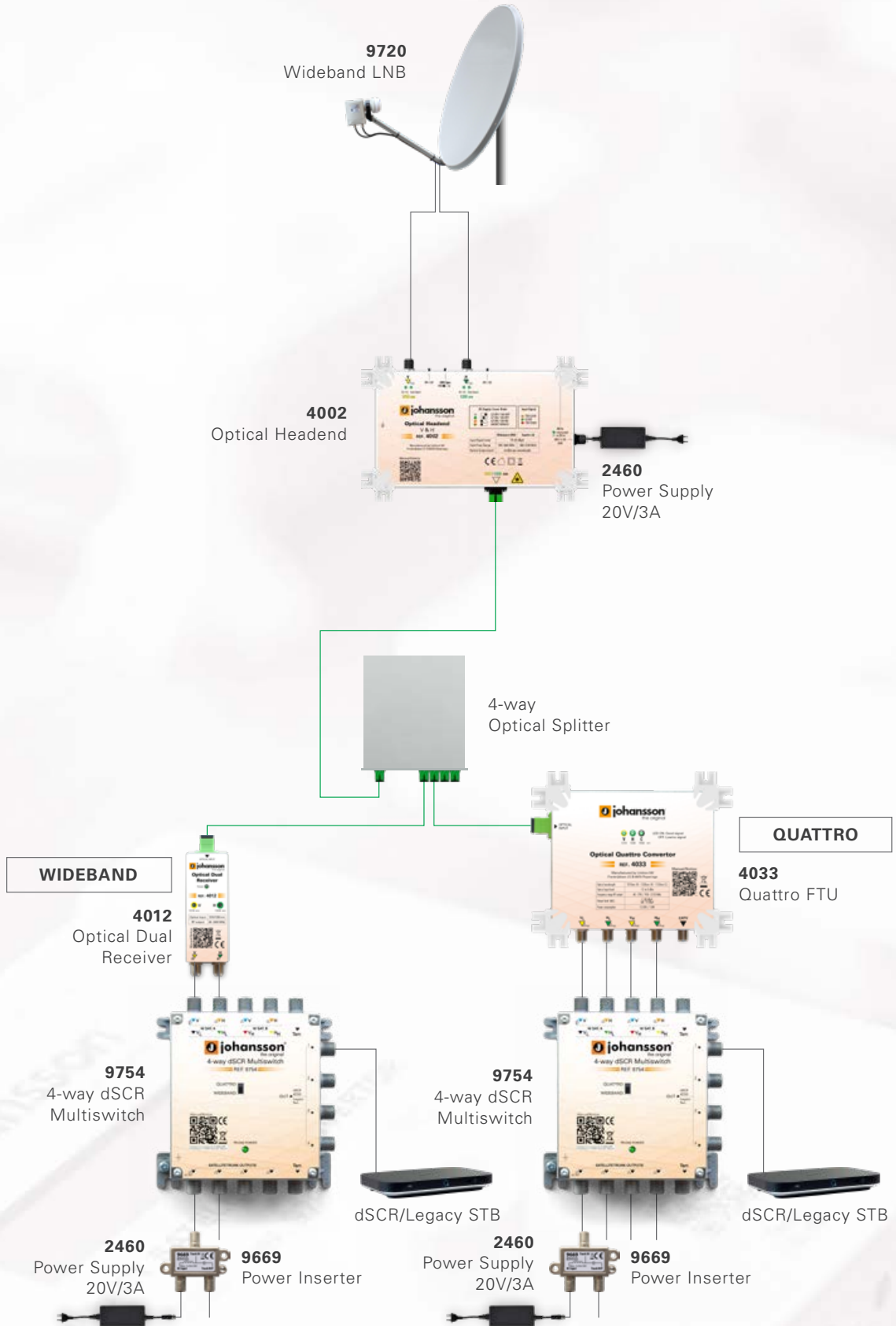

USE CASE 7

Hybrid dSCR Solution: Wideband to SCR + CATV (up to 64 splits)

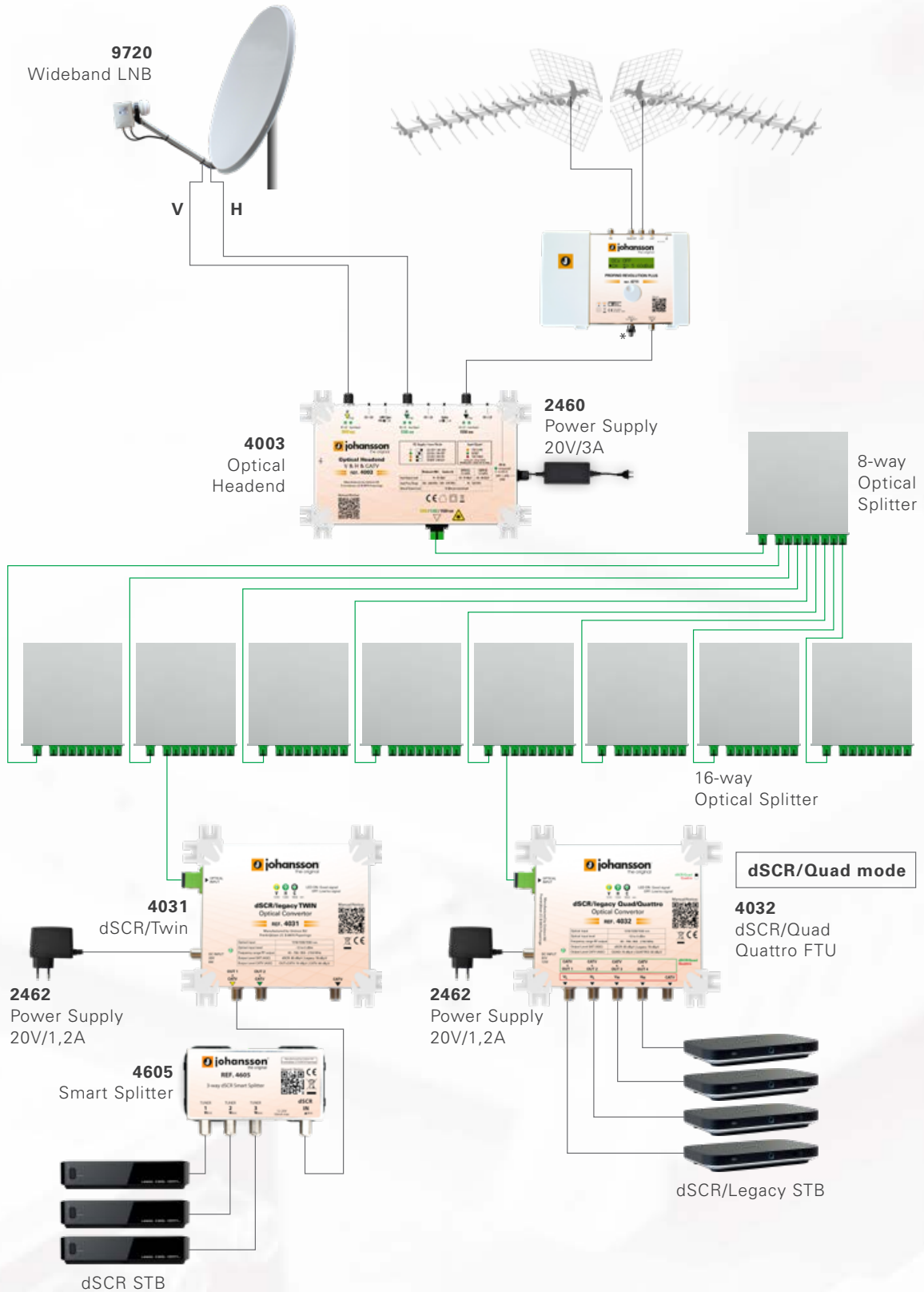

Fiber Optical Distribution

USE CASE 8

Legacy and dSCR: Wideband to SCR + CATV (up to 64 splits)

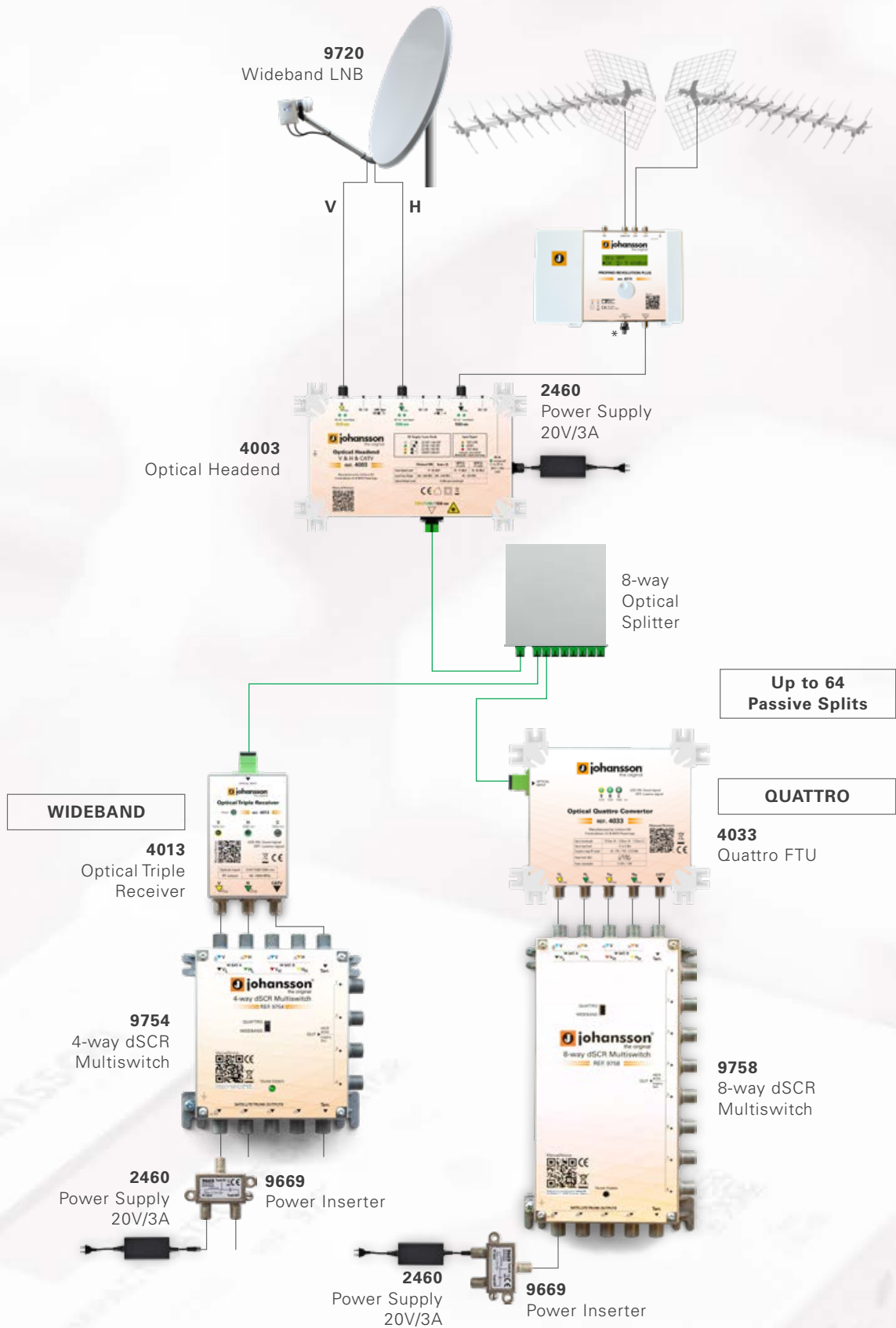



johansson
since 1962



Our flexible team offers you
for **every evolution**
a **custom made solution**

UNITRON NV | Frankrijcklaan 27 | B-8970 Poperinge | Belgium
T + 32 57 33 33 63 | sales@unitrongroup.com
www.unitrongroup.com

