

Ultra Series

Industrial Router

UR75

Milesight



Milesight UR75 is an high-performance industrial-grade 5G router designed for a variety of M2M/IoT applications. Made for high-performance, industrial standard, it has quad-core CPU and cellular module that supports global WCDMA, 4G LTE and 5G sub-6 Ghz NSA and SA network.

Meanwhile, UR75 also supports 5-port Gigabit Ethernet switch, RS232/RS485 serial ports and Digital input/Digital output, which enable users to scale up M2M application combining data collection and high-speed transmission in limited time and budget.

UR75 is particularly suitable for smart grid, digital media installations, industrial automation, telemetry equipment, medical device, digital factory, finance, payment device, environment protection, water conservancy and so on.

◆ Ultra Fast Connectivity

- Industrial-grade quad-core CPU ARM Cortex-A55 with big memory, providing high performance for data transmission
- Global 5G (NSA/SA)/4G LTE network with dual SIM cards for backup between multiple carrier networks
- Dual carrier aggregation (2CC CA) is supported in the 5G Sub-6GHz, enabling wider signal coverage with superb download speed up to 4.67 Gbps
- Plug& play, supply lightning transmission via Gigabit Ethernet ports or USB Type-C interface
- Support Wi-Fi 6, allows 2.4G & 5G dual band concurrent connections up to 1.8 Gbps download speed

◆ Industrial-Grade Design

- Wide operating temperature range from -30°C to 60°C and industrial design for harsh environment
- Rugged enclosure with IP30 protection, optimized for DIN rail or shelf mounting.
- Equipped with I/O, serial port, GPS for industrial transmission applications
- 3-year warranty included

◆ Security & Reliability

- Automated failover/failback backup among Ethernet, Cellular (dual SIM) and Wi-Fi
- Secure transmission with VPN tunnels like IPsec/OpenVPN
- Embedded with hardware watchdog to automatically recover from various failures, ensures the highest level of availability
- Equipped with multiple security protection measures such as ACL, DMZ, SYN-Flood protection, and data filtering to ensure that the network is secured.
- Support policy routing and NAT for more secure intranet access

◆ Ease of Maintenance

- DeviceHub provides easy setup, mass configuration, and centralized management of remote devices.
- The user-friendly web interface design and more than one option for upgrading. helps the administrator to manage the device easily
- Support multilevel user authorities for security management

◆ Specifications

Hardware System	
CPU	Quad-core ARM Cortex-A55, 2 GHz
Memory	1 GB LDDR4x RAM and 1 GB NAND Flash
Extendable Storage	1 × M.2 NVMe SSD Interface
Cellular Interface	
Network	5G NR SA & NSA/4G LTE/WCDMA
Frequency	5G Sub-6: N1/N3/N5/N7/N8/N20/N28/N38/N40/N41/N77/N78 LTE FDD: B1/B3/B5/B7/B8/B20/B28/B32 LTE TDD: B38/B40/B41/B42/B43 WCDMA: B1/B5/B8
Antenna	4 × 50 Ω SMA Connectors (Center PIN: SMA Female)
SIM Slot	2 (Mini SIM-2FF)
Ethernet Interface	
Numbers	5 × 10/100/1000 Mbps
Property	1 × WAN +4 × LAN
Mode	Full or Half Duplex (Auto-Sensing)
PoE	4 × 802.3 af/at PoE PSE on LAN Ports (Optional)
Wi-Fi Interface (Optional)	
Antenna	4 × 50 Ω SMA Connectors (Center PIN: RP-SMA Female)
Standards	IEEE 802.11b/g/n/ax 2 x 2 MIMO, 2.4 GHz IEEE 802.11a/n/ac/ax 2 x 2 MIMO, 5 GHz
Max Bit Rate	2.4 GHz: 600 Mbps, 5 GHz: 1200 Mbps
Modes	AP and Client ¹ Mode
Security	WEP/WPA/WPA2 authentication, WEP/TKIP/AES encryption
GNSS	
Antenna	1 × 50 Ω SMA Connector (Center PIN: SMA Female)
Technology	GPS/GLONASS/Beidou/Galileo/QZSS
Protocol	NMEA 0183
Serial Interface	
Numbers	1 × RS232 + 1 × RS485
Connector	3.5 mm Terminal Block
Baud Rate	300bps to 230400bps

¹ Under Development

DI/DO	
Numbers	1 × DI (Dry Contact) + 1 × DO (Wet Contact), Galvanic Isolation
Connector	3.5 mm Terminal Block
Maximum V/A	0.3A@30VDC (DO)
Others	
USB	1 × USB 3.0 (Type-C) for Power Supply, Network Supply and Debug
Reset Button	1 × RESET
LED Indicators	1 × SYSTEM, 1 × SIM1, 1 × SIM2
Built-in	Watchdog, Timer
Software	
Network Protocols	IPv4/IPv6, TCP, UDP, DHCP, HTTP, HTTPS, ARP, NTP, DNS, ARP, SSH, VLAN, etc.
VPN	IPsec, OpenVPN, LT2P, PPTP
Security	Access Control, DMZ, Port Forwarding, SYN-Flood Protection, Filtering (IP & MAC & Domain)
Management	Web, DeviceHub, MilesightVPN
Reliability	WAN Failover, Dual SIM Backup
Serial Port	Transparent (TCP Client/Server, UDP), Modbus Master, Modbus Gateway (Modbus RTU to Modbus TCP)
Power Supply and Consumption	
Power Connector	2-pin 3.5 mm Terminal Block
Power Input	1. 9-48 VDC, with Surge-Protection and Reverse Polarity Protection 2. 5V, 3A by Type-C Port
Power Consumption (In Non-PoE mode)	Without Wi-Fi: Typical 2.8 W, Max 5.5 W With Wi-Fi: Typical 7 W, Max 13.7 W
Physical Characteristics	
Ingress Protection	IP30
Housing	Metal
Dimension	135 x 115 x 36.4 mm (5.31 x 4.53 x 1.43 in)
Installation	Desktop, Wall or DIN Rail Mounting
Environmental	
Operating Temperature	-30°C to +60°C (-22°F to +140°F)
Storage Temperature	-40°C to +85°C (-40°F to +185°F)

Ethernet Isolation 1.5 kV RMS

Relative Humidity 0% to 95% (Non-condensing) at 25°C/77°F

◆ Dimensions(mm)

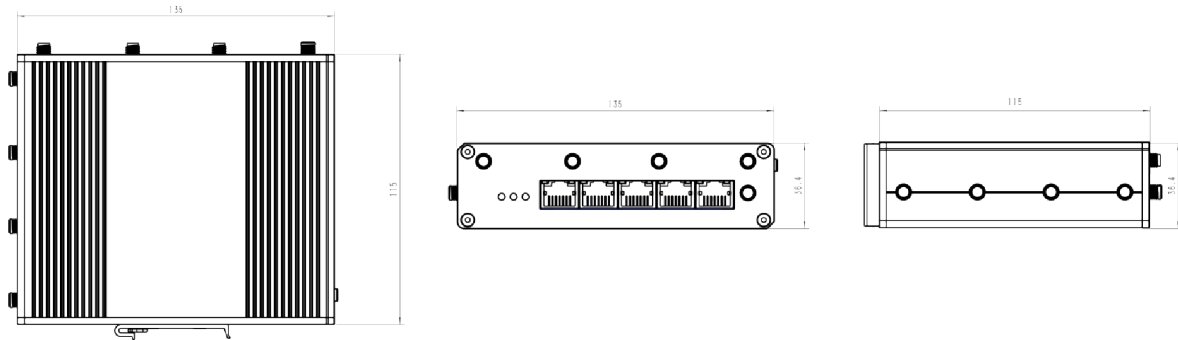

◆ Accessories

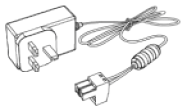

1 × Power Adapter

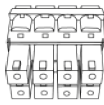

1 × 8-Pin Pluggable Terminal

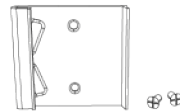

1 × DIN Rail Kit



4 × Stubby Cellular Antennas

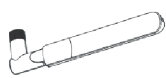

4 × Stubby Wi-Fi Antennas (**Wi-Fi Version Only**)

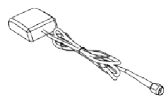

1 × GPS Antenna

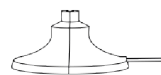

Antenna Magnetic Mount (**Optional**)

***Note:** Contact us if you need any other special accessories or customized accessories.